

MODEL LCR - 740

LCR BRIDGE

INSTRUCTION MANUAL

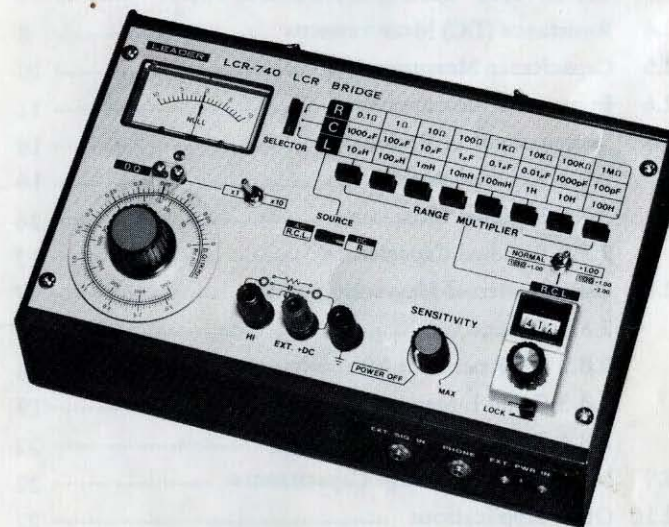

LEADER ELECTRONICS CORP.

2-6-33 TSUNASHIMA-HIGASHI, KOHOKU-KU,
YOKOHAMA, JAPAN.

PHONE: (045) 541-2121 TELEX: J47780 JPLEADER

LEADER INSTRUMENTS CORP.

380 OSER AVENUE, HAUPPAUGE, N.Y. 11788 U.S.A.
PHONE: (516) 231-6900

TELEX: 510-227-9669 LEADER HAUP

LEADER ELECTRONICS CORP.

CONTENTS

SECTION	PAGE
1. DESCRIPTION	
1.1 General	1
1.2 Specifications	1
1.3 Controls and Connectors	3
2. OPERATION	
2.1 Precautions in Use	6
2.2 Readout of Measured Values	7
2.3 Use of "1.00" Setting of NORMAL switch	7
2.4 Resistance (DC) Measurements	8
2.5 Capacitance Measurements	10
2.6 Inductance Measurements	11
2.7 Measurement of Residuals	16
2.7.1 Residual Resistance	16
2.7.2 Residual Inductance	16
2.7.3 Residual Capacitance	17
2.8 Use of External Measuring Sources	17
2.8.1 General	17
2.8.2 DC Resistance Measurements	18
2.8.3 C and L Measurements	19
2.8.4 Determination of D and Q	22
2.9 Measurement of Large Capacitances	22
2.10 Other Applications	22
2.10.1 Transformer Measurements	22
2.10.2 Tolerance, or Error, Measurements	23
2.11 Battery Replacement	24

3. PRINCIPLE OF OPERATION	
3.1 Bridge Circuits	24
3.2 Bridge Sources	26
3.3 Null Detection	27
SCHEMATIC DIAGRAM	28

OPERATING INSTRUCTIONS

SECTION 1 DESCRIPTION

1.1 General

The LCR-740 is designed for measurements of resistance (R), capacitance (C) and inductance (L) over a wide range. The instrument is completely self-contained, including a battery for measurements of R (DC); as well as, C and L with a 1kHz oscillator and null detecting amplifier system. A 3-digit readout is used for measured values. Input connections are provided for use of external DC or AC (50Hz-40kHz) sources, and for an AC Adapter (LPS-169).

1.2 Specifications

Resistance Measurement

Range	0.001 Ω to 11M Ω in eight ranges with +10% extension at each range.
Minimum Resolution	1m Ω (0.001 Ω)
Accuracy (at 20° ±5°C)	Range: 1 Ω - 100k Ω ±(0.5%+0.1% f.s.) 1M Ω ±(1%+0.1% f.s.) 0.1 Ω ±(2%+0.1% f.s.)

Residual Terminal Resistance

Approx. 3m Ω

Capacitance Measurement

Range	1pF to 11,000 μ F in eight ranges with +10% extension at each range.
-------	--

Minimum Resolution	1pF.
Accuracy (at 20° ±5°C)	Range: 1000pF-100 μ F ±(0.5%+0.1% f.s.) 100pF ±(1%+0.1% f.s.) 1000 μ F ±(3%+0.1% f.s.)

Residual Terminal Capacitance

Approx. 3pF

Inductance Measurement

Range	0.1 μ H to 1100H in eight ranges with +10% extension at each range.
Minimum Resolution	0.1 μ H
Accuracy (at 20° ±5°C)	Range: 100 μ H-10H ±(0.5%+0.1% f.s.) 100H ±(1%+0.1% f.s.) 10 μ H ±(3%+0.1% f.s.)

Residual Terminal Inductance

Approx. 0.3 μ H

Dissipation Factor (D) and Quality Factor (Q) Measurements

Range	0.01 to 30, at 1kHz, in two ranges.
Accuracy	±10% +3 scale divisions
Measuring Sources	DC: Internal or external for resistance measurements. AC: Internal 1kHz, or external 50Hz to 40kHz, for capacitance and inductance measurements.

Power Supply	9V DC (006P, NEDA 1604, or equivalent).
Size and Weight	85(H) × 240(W) × 170(D) mm; approx. 2kg.
Accessory supplied	Cord w/minim-plug and clips 1 ea.
Option, Separate Order	AC adapter, LPS-169.
Operating Temp. Range	0 – 40°C
Operating Humidity Range	0 – 85%

1.3 Controls and Connectors

A. Front Panel, Fig. 1-1

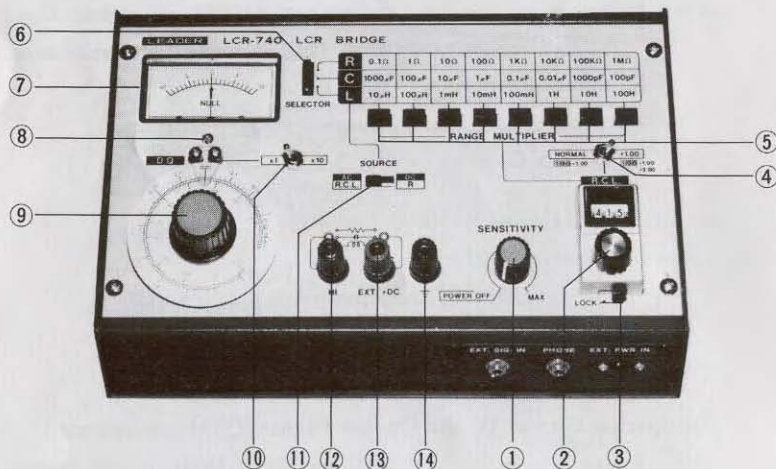

Fig. 1-1 Front panel controls.

- ① POWER switch and SENSITIVITY control: Power switch turns unit on or off, and sets detector sensitivity for A.C. measurements.
- ② R C L indicator: 3-digit display controlled by knob rotation; actual values depend on settings of the RANGE MULTIPLIER switches.

- ③ Lock knob: For locking the R C L indicator, 2, at a predetermined setting when testing components for tolerance, etc.; normally set at the right, or “free”, position.
 - ④ NORMAL +1.00 switch: Set at NORMAL in general measurements for direct readout of R C L indication; +1.00 setting used when extending the upper measuring limit.
 - ⑤ RANGE MULTIPLIER switches: For selecting the ranges of components under measurement.
 - ⑥ SELECTOR switch: To be set at R, C, or L (resistance, capacitance, or inductance, respectively) depending on the component to be measured.
 - ⑦ NULL indicator: 10-0-10 scale used for DC resistance measurements and 0-10 scale (at right of 0) for capacitance and inductance measurements.
 - ⑧ Mechanical zero adjust for NULL indicator.
 - ⑨ D, Q dial: With two scales, outer for dissipation factor, D, and inner for R_E (equivalent series resistance) calibrated for values at 1kHz. But actual equivalent series resistance must be calculated through 2.5 or 2.6 on page 10 and page 11.
 - ⑩ $\times 1 - \times 10$ switch: Selects the multiplier for the D and R_E readings on the D, Q dial.
 - ⑪ SOURCE switch: Selects the internal bridge operating source, DC for DC resistance measurements and AC at 1kHz for resistance, capacitance and inductance measurements.
 - ⑫ RED HI
 - ⑬ BLUE EXT. +DC
- For connections to the unknown component under measurement; both are “floating” terminals from ground.
- ⑭ BLACK terminal: For grounding to the case.

B. Rear Side of Case, Fig. 1-2

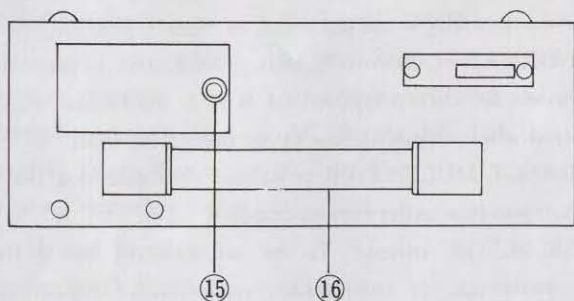

Fig. 1-2 Rear side of case.

⑮ Cover fastener for the battery compartment.

⑯ Carrying handle.

C. Front Side of Case, Fig. 1-3

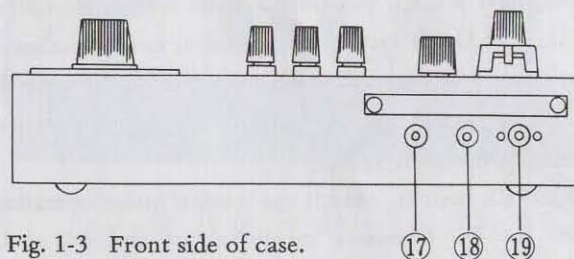

Fig. 1-3 Front side of case.

⑰ EXT. SIG. IN jack: For external AC source in 50Hz-40kHz range; insertion of the mini-plug (on connecting cord) automatically turns off the internal 1kHz oscillator.

⑱ PHONE jack: For insertion of the earphone plug when using audible signals in common with meter indication for null

condition; connection to a scope is possible for the same purpose.

⑲ EXT. PWR IN jack: For connection to the LPS-169 AC Adapter; when inserted, the internal battery is turned off automatically.

SECTION 2 OPERATION

2.1 Precautions in Use

- A. Always set the POWER switch at OFF during standby periods, or when the bridge is not in use. This will prolong the internal battery life. (Use of the AC adapter, LPS-169, is recommended, where applicable.)
- B. Check the center 0 setting of the NULL meter; this will prevent errors in DC resistance measurements. If off, set the POWER switch at OFF and adjust the center screw, if necessary see figure.

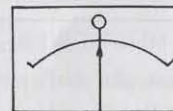

- C. Connections of the unknown component to the measuring terminals, RED and BLUE, must be as short as possible. This is very important when small values are under measurement.
- D. When the R C L indicator knob is locked by Lock Knob, do not force rotation.
- E. The specified AC adapter is the LPS-169; do not use any other type.

2.2 Readout of Measured Values

When the bridge has been balanced with the R C L indicator and RANGE MULTIPLIER settings, the readout is made as described in the examples given below.

IMPORTANT!! NORMAL +1.00 switch setting at "NORMAL".

RANGE MULTIPLIER		RCL Indication	MEASURED VALUE
R	100Ω	6.85	685Ω (=100 × 6.85)
	10k	6.85	68.5kΩ (= 10 × 6.85)
	100kΩ	6.85	685kΩ (=100 × 6.85)
C	100pF	0.68	68pF (=100 × 0.68)
	0.1μF	6.85	0.685μF (=0.1 × 6.85)
	10μF	6.85	68.5μF (=10 × 6.85)
L	10μH	0.68	6.8μH (=10 × 0.68)
	10mH	6.85	68.5mH (=10 × 0.685)
	10H	6.85	68.5H (=10 × 6.85)

NOTE: The RANGE MULTIPLIER should be set, whenever possible, so that the null point is at three significant figures in the indication.

2.3 Use of "+1.00" Setting of NORMAL Switch

In general measurements, this switch is set at NORMAL. However, when measuring at the higher end, i.e., above the 9.99 indication in a given multiplier range, it is possible to extend the range by 10%.

This is done by rotating the indicator knob to 9.00 and setting the switch at +1.00.

The readings will then start from 9.00 to 0.00 although the values will be from 10.00 up to 11.00 (by adding "1.00" to the readings). Examples are given in the table which follows.

At "+1.00" setting of the NORMAL switch	
READING	MEASURED VALUE
9.00	10.00 (=9.00 + 1.00)
9.01	10.01
9.50	10.50
9.99	10.99
0.00	11.00 (=10.00 + 1.00)

After use of the "+1.00" setting, always reset the switch to NORMAL. This is to prevent errors in subsequent measurements since "1.00" will be added to the first significant figure, for example, 5.55 will be indicated when the actual value is 6.55.

2.4 Resistance (DC) Measurements

1. Connect the unknown component to RED and BLUE terminals.
2. Switch settings:

SELECTOR at "R", see figure.

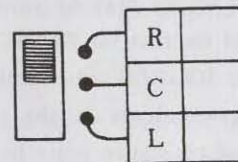

SOURCE at DC/R, see figure.

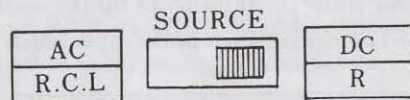

NORMAL +1.00 at NORMAL.

POWER switched at ON. (Note: The control is not used in DC measurements.)

RANGE MULTIPLIER at the range to be used. If not known, note the NULL meter. Set at a higher range if the pointer swings to the right and vice versa.

3. Rotate the RCL knob until the NULL meter indicates at center 0. If necessary, alter the RANGE MULTIPLIER setting.
4. Read the RCL indication and apply the range multiplier in use for the resistance value. (For readouts, etc., see Sect. 2.2 and 2.3.)

NOTES: A. When using the $1M\Omega$ range, the null indication may not be well-defined; in this case, refer to Sect. 2.8.2. Alternatively, if the resistor or device, under measurement is non-inductive, the internal AC (1kHz) source may be used; see Sect. 2.6. The only changes are that the SELECTOR switch is set at "R" and the SOURCE switch setting is at AC/R.C.L.

B. At measurements in the 0.1Ω range, the residual terminal resistance must be taken into account, see Sect. 2.7.1.

2.5 Capacitance Measurements

1. Control settings:

SELECTOR switch at "C", see figure.

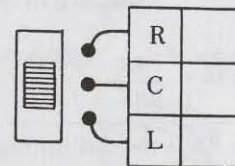

SOURCE switch at AC/R.C.L.

D.Q, dial at 0.

D, Q switch at $\times 1$.

NORMAL +1.00 switch at NORMAL.

POWER switched to ON.

SENSITIVITY control adjusted for NULL meter reading at "5"

2. Connect the unknown component to RED and BLUE terminals.
3. Adjust RANGE MULTIPLIER switches and RCL knob for minimum pointer swing, i.e., at or towards 0.
4. Adjust the D, Q dial and note the null condition; adjust the SENSITIVITY control if necessary.
5. Readjust the RCL knob and D, Q dial for the best null indication. If the dial setting is around 3.0, set the D, Q switch at $\times 10$.
6. Readouts:

$$\text{Capacitance} = (\text{RANGE MULTIPLIER}) \times (\text{RCL indication}); \text{ also see Sect. 2.2. and 2.3.}$$

Dissipation factor, D, at 1kHz: Direct from the dial; multiply by 10 if the D, Q switch is at $\times 10$.

Equivalent series resistance, R_s : The value is calculated from the relation –

$$R_s, \text{ in } \Omega = \frac{RE}{C\mu F} = \frac{RE \times 10^6}{CpF}$$

where RE is the dial reading.

NOTES: A. Good capacitors will have very low D and vice versa.

B. At measurements up to 1000pF, the residual terminal capacitance must be taken into account, see Sect. 2.7.3.

C. For measurements of large capacitances (electrolytics, polarized, etc.) see Sect. 2.9.

2.6 Inductance Measurements

1. Control settings

Power switch: OFF

Selector switch: L

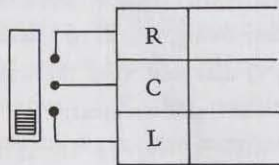

Source switch: AC

SOURCE

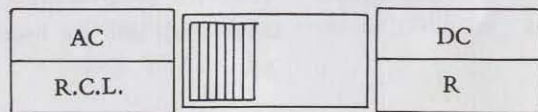

DQ $\times 1 - \times 10$ switch: $\times 1$



Normal – +1.00 switch: Normal

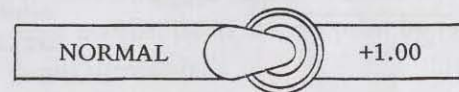

Range multiplier switch: 10mH

DQ dial: Approximately at center (Q=about 0.3)

RCL digital dial: Near 5.00

2. Connect the unknown component between the red terminal (H1) and blue terminal (EXT+DC).
3. Rotate the knob of SENSITIVITY clockwise slowly. Turn the unit on and adjust so as to have the meter needle moved to the right from NULL point and pointed between 6 and 7. (This is very critical.)
4. Select a measurement range by the following procedures prior to start measurement of a completely unknown L. However, if the component under test is known about its inductance, select a range multiplier and RCL dial corresponding to the known value.
 - (a) Rotate DQ dial, and locate a point where clear dip takes place while turning.
In the case of Q of which L is low, care should be exercised not to overlook such a point as it is shallow.

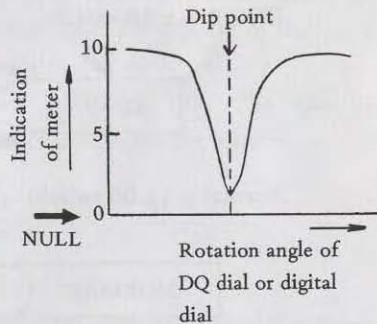
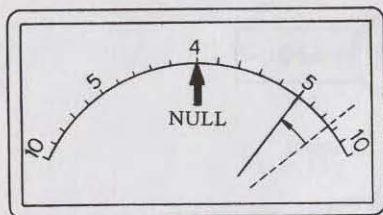

While DQ dial is turned in the same direction, the meter needle approaches to NULL once, and then sway back to the right. At this time, the point where the needle comes closest to the NULL point is called as the dip points.

Although the indicator needle approaches to NULL, DQ dial finally comes to zero (rotated counterclockwise to its extreme point) without showing the dip point. In such a case select other range by pushing range switch, and try to locate the dip point in the same manner.

- (b) In case the dip point cannot be located even if DQ dial is rotated fully clockwise ↻, set the X1 – X10 switch at X10 and try to locate a point.

When a dip point cannot still found, select other range by pushing range switch, and try to locate the dip point. At this time, try to find such a point while adjusting the SENSITIVITY knob so as to have the indicator needle pointed around between 6 and 7 in the right hand side.

If such a point can never be found, check the unit if its wire is broken by measuring DC resistance at R range.

5. When the dip point can be found, take following steps. Set the DQ dial at the point where the largest dip takes place. Then rotate the RCL digital dial to find the point where the largest dip occurs.
(At this time, try to find a dip point while adjusting the SENSITIVITY knob so as to have the indicator needle pointed around between 6 and 7 in the right hand side.)
6. In the same manner, locate the dip point by turning DQ dial and RCL dial alternately.

Caution

- (a) It is impossible to make measurement of inductance when DQ dial becomes almost zero after being rotated counterclockwise ↻. This is because that DC resistance component of the inductance under test is too large, or Q of coil is less than 0.1, the measuring limit of this instrument, due to the core is too low in Q at a measuring frequency (this instrument is 1kHz). On the contrary, if DQ dial comes to almost its extreme end being rotated clockwise even if X1 – X10 switch is set at X10, it is due to the fact that Q is larger than 30 and outside the measuring range. In such a case, add a resistor of several ohms to several tens ohms to the inductor to be measured in series to have Q reduced to less than 30 and make measurement. But a resistance must be the lowest as possible to bring "Q" to be within 30. (Ferrite core etc. are about 100 to 200 in Q.) A true Q can be obtained from a measuring frequency f and a measured value by using the following formula:

For instance, from Q_R and L to be obtained when resistor R is added in series;

$$L = 240\text{mH}, Q_R = 13.5, R = 100\Omega, f = 1\text{kHz}$$

$$Q = \frac{1}{\frac{1}{QR} - \frac{R}{2\pi fL}} = \frac{1}{\frac{1}{13.5} - \frac{100}{2\pi \times 1 \times 10^3 \times 240 \times 10^{-3}}} = 128.87$$

- (b) If RCL digital dial indicates less than 0.99, select a range one step lower, or if it indicates 9.99, select a range one step higher by push button, and make readjustment of the unit. (Attention is paid if dial exceeds 9.99, it becomes 0.00.)
7. Further try to locate the point where the largest dip takes place by turning DQ dial and RCL digital dial alternately. At this time, the sensitivity knob is slowly turned to increase, and try to find out a sharp dip point.
A further final dip point should be located by the following procedures.
- (a) Hold the outer edge of disk of DQ dial and rotate it clockwise by 1 to 2mm, and try to find the dip point by finely adjusting RCL digital dial. At this time, if such the dip point tends to become shallower than the previous condition (needle sways to the right from null point), rotate DQ dial in reverse direction by about 1 to 2mm and cause the needle to dip by adjusting the digital dial.
- (b) When the needle is adjusted to dip further, rotate DQ dial further in the direction where needle dips more by about 1 to 2mm, and then try carefully to find a point where the largest.
8. Equivalent series resistance, R_s : The value is calculated from the relation—

$$R_s, \text{ in } \Omega = \frac{L \text{ in henrys} \times 10^{-6}}{RE} = \frac{L \text{ in mH} \times 10^{-3}}{RE}$$

where RE is the dial reading.

9. If an inductor to be measured is of iron core type, it has B/H characteristic, therefore, measured values will be varied depend on measuring conditions. Please refer to Par. 5-6-3, Measurement with external oscillator used.

2.7 Measurement of Residuals

For accurate measurements, the residual terminal values at the 0.1Ω , 100pF , and $10\mu\text{H}$.

For accurate measurements at the lowest ranges, 0.1Ω , 100pF , and $10\mu\text{H}$, it is necessary that the residual terminal values are known. The procedures are given below.

2.7.1 Residual Resistance

1. Control settings:

RANGE MULTIPLIER switch at 0.1Ω .

SELECTOR switch at "R".

SOURCE switch at AC/R.C.L.

SENSITIVITY control at full clockwise.

D, Q dial at 0.

- Short the RED and BLUE terminals with heavy wire, or metal strap; if leads are to be used, short the free ends.
- Adjust the RCL knob for the null condition and read the indicator. The indicated value should be subtracted from the value measured under the conditions given in Sect. 2.4.

Example: Residual resistance 0.002Ω (Indication=0.02).

Measured unknown 0.05Ω .

Actual resistance $0.498 (=0.500 - 0.002)$.

2.7.2 Residual Inductance

The same procedure, using shorted terminals, as given in Sect. 2.7.1 is used with exception of the following:

RANGE MULTIPLIER Switch at $10\mu\text{H}$.

SELECTOR switch at "L".

The indicated value should be subtracted from the value measured at the $10\mu\text{H}$ and $100\mu\text{H}$ settings of RANGE MULTIPLIER.

Example: Residual inductance $0.16\mu\text{H}$.
Measured unknown $25.4\mu\text{H}$.
Actual inductance $25.24\mu\text{H}$ ($25.4 - 0.16$).

2.7.3 Residual Capacitance

1. Remove connections, if any, across the RED and BLUE terminals, i.e., the circuit must be "open".

2. Control settings:

RANGE MULTIPLIER switch at 100pF .

SELECTOR switch at "C".

SOURCE switch at AC/R.C.L.

SENSITIVITY control at full clockwise.

D, Q dial at 0.

3. Adjust the RCL knob for the null condition and read the indicator. The indicated value should be subtracted from the value measured at the 100pF and 1000pF settings of RANGE MULTIPLIER.

Example: Residual capacitance 2pF .
Measured unknown 150pF .
Actual capacitance 148pF ($150 - 2$).

2.8 Use of External Measuring Sources

2.8.1 General

Procedures with use of external sources for measurement of DC resistance and for capacitance and inductance are given in this section.

For the C and L measurements, the frequency range is from 50Hz to 40kHz. The generator should have a sine-wave output at 1 to $5V_{\text{rms}}$ into approximately $5\text{k}\Omega$.

2.8.2 DC Resistance Measurements

When measuring the DC resistance of unknowns at high values with the internal battery source, the null indication may not be well-defined. In this case, an external DC source can be used.

- IMPORTANT!!**
- Set the high voltage input at off when making lead connections.
 - Take care not to come into contact with the high voltages.
 - The protective resistor must always be used at the input circuit.
 - Turn off the DC input when changing the RANGE MULTIPLIER settings; confirm that the proper voltage and range are being used, otherwise there is danger of damaging the internal circuit components.
- Set the POWER switch (SENSITIVITY control knob) at off.
 - Set the external DC supply at off.
 - Connect the negative lead to the BLACK terminal, and the positive lead to the BLUE (EXT. +DC) terminal, see figure.
 - Connect the unknown across the RED and BLUE terminals.
 - Rotate the RCL knob and read the indicator. Apply the proper multiplier; also see Sect. 2.2 and 2.3.

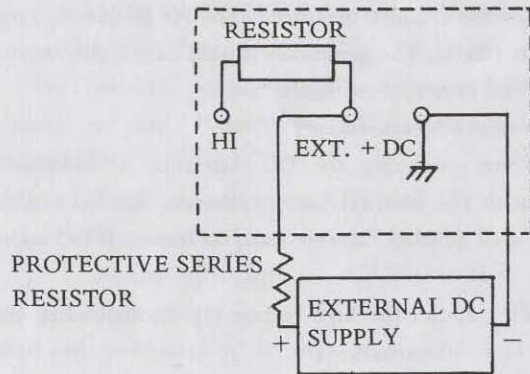

NOTE: The DC voltages to be used depend on the RANGE MULTIPLIER settings as given in the table which follows.

RANGE MULTIPLIER SETTING	1k Ω	10k Ω	100k Ω	1M Ω
Maximum DC Input	30V	70V	220V	500V
Protective Series Resistor	>180 Ω	>2.2k Ω	>27k Ω	>56k Ω

2.8.3 C and L Measurements

A. Measuring Procedure

1. Input Connections:

The generator output, using the accessory connecting cord, is connected to the EXT. SIG. IN jack at the front side of the case, see figure.

Note that a 1 μ F capacitor is in series with the "hot" lead.

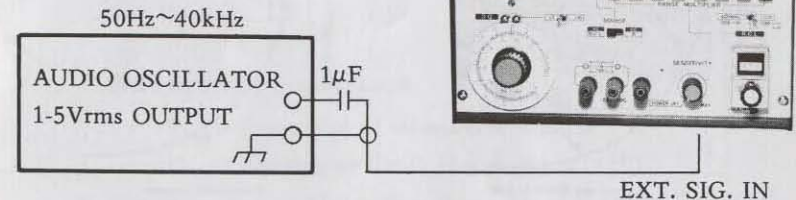

- Set the SELECTOR switch at "C" or "L", whichever unknown component is under measurement.
- Set the SOURCE switch at AC/R.C.L. (When the external input is connected, the internal 1kHz source is cut out of circuit.)
- Measurements for C or L are made as described in Sect. 2.5 and 2.6 respectively. Adjust the controls – SENSITIVITY, D, Q dial and RCL indicator – and RANGE MULTIPLIER switch settings as required for the null condition.
- The C or L values are determined by the RANGE MULTIPLIER setting and the RCL indicator.

B. L Measurements (with iron core)

An external oscillator is used when it is desired to make measurement of inductance at a desired frequency. Especially when a coil with iron core used (power transformer, etc.) is measured, its inductance will be varied by drive voltage of an oscillator due to non-linearity of B/H curve. Also it varies depend on frequency.

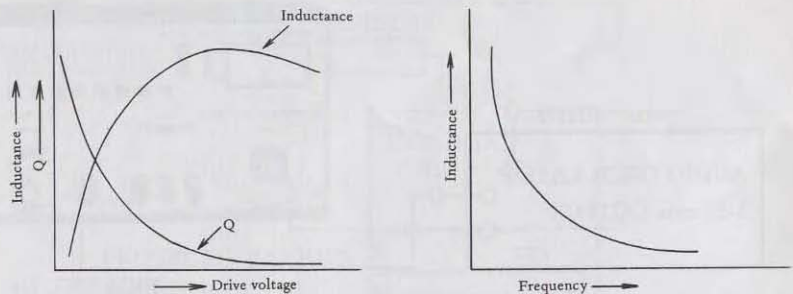

Generally in this case, inductance at the time when drive voltage at a fixed frequency is zero, that is inductance of initial permeability, is used as comparison.

Now, to obtain this value, an external oscillator is used, and inductance of zero voltage is to be obtained by plotting voltages applied and values of inductance.

(TO OBTAIN THIS VALUE, PLOT L VS VOLTAGE APPLIED AND EXTRAPOLATE TO ZERO VOLTAGE)

In the case of material of which Q is high such as Ferrite core (Pressurized powdered iron core, oxide magnetic core material), there is no substantial variation in inductance by voltage level until it is saturated.

1. Connect a sine wave oscillator of 50Hz to 40kHz to EXT, SIG. In terminals as shown in Fig.
2. Set the frequency of the sine wave oscillator to a measuring frequency, and set its output voltage at 3 Vrms.
3. Connect an unknown component to its measuring terminal.
4. Subsequent procedures are the same as those of 2.6.

2.8.4 Determination of D and Q

A. For Capacitance: The dissipation factor depends on the frequency and is calculated from the relation –

$$D_f = \frac{F_{Hz}}{1000} \times D$$

where D_f = Dissipation factor

F_{Hz} = Frequency of measurement in Hz

D = Reading on the D, Q dial ($\times 1$ or $\times 10$)

B. For Inductance: The quality factor depends on the frequency and is calculated from the relation –

$$Q_f = \frac{F_{Hz}}{1000} \times Q$$

where Q_f = quality factor

F_{Hz} = Frequency of measurement in Hz

Q = Reading on the D, Q dial ($\times 1$ or $\times 10$)

2.9 Measurement of Large Capacitances

Capacitors with high capacitance, mainly used in filter circuits, usually have a certain amount of inductance. In order to minimize the inductive effects, measurements should be made at a low frequency, for example at 120Hz, using an external AC source, see Sec. 2.8.3.

Since the AC voltage across the capacitor is low, reliable measurements can be made without use of the polarizing (DC) voltage.

2.10 Other Applications

2.10.1 Transformer Measurements

A. Turns Ratio

The turns ratio between different windings can be determined

by measuring the inductance of the windings under no load conditions.

The ratio is determined from the relation –

$$T = \sqrt{\frac{L_1}{L_2}}$$

where T = turns ratio,

L_1 and L_2 respectively are inductances of the primary and secondary windings.

B. Leakage Inductance

Since most of the flux leakage in output transformers is through air, the leakage inductance can be measured by shorting the secondary winding and measuring the inductance from the primary side and vice versa. (Low leakage measured from the primary side indicates the extension of bandwidth towards the higher frequencies.)

2.10.2 Tolerance, or Error, Measurements

When a large number of components, such as resistors, must be checked to be within given limits, the procedure is as follows:

1. Assume that the resistors are being checked for tolerance, set the switches for “R” measurements, see Sect. 4.
2. Connect the “standard” resistor to the RED and BLUE terminals.
3. Adjust the SELECTOR switch setting to “R”, and SOURCE switch to DC/R.
4. Adjust the RCL knob for null indication and lock the setting.
5. Set the “standard” at, say +5% and –5% of the initial value. Note the null meter readings at the two values to be used for the limits.

6. Remove the “standard” and connect the test resistor in place as required and note the error on the NULL meter.

NOTES: a. This process is applicable when testing capacitors and coils by setting the SOURCE switch at AC/R.C.L.
b. Release the lock on the RCL indicator knob after the tests.

2.11 Battery Replacement

The internal battery, 006P, NEDA 1604, or equivalent, should be replaced when the 1kHz oscillator is inoperative. This condition can be detected when the meter pointer does not swing when the SOURCE switch is set at AC/R.C.L. Pull out the captive fastener on the compartment cover at the back for removal and installation, see figure.

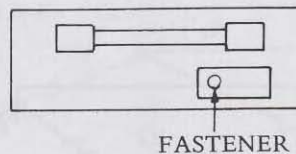

SECTION 3 Principles of Operation

3.1 Bridge Circuits

Three basic bridge configurations are used in the LCR-740. The circuit elements are indicated with the following notation –

Unknowns under measurement:

- Rx Resistor
- Cx Capacitor
- Lx Inductor (coil)

In bridge arms:

- Rs Standard resistance, for R
- Cs Standard capacitance, for C and L

Rm Range multiplier

Rv Variable resistor, with RCL indicator

D, or Q Variable resistor for dissipation factor, D, and Quality factor Q.

Sources

DC Internal, or external

AC Internal (1kHz) or external

Detection

M O-center for DC resistance

DET Amplifier system + meter

A. DC resistance bridge

The conventional Wheatstone bridge circuit is used, where

$$R_x = \frac{R_m \times R_v}{R_s}$$

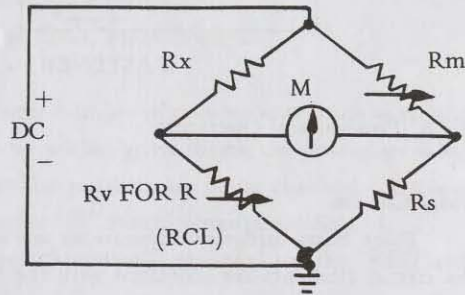

B. Capacitance bridge

Capacitance is measured with the series bridge, where

$$C_x = \frac{R_v}{R_m} C_s$$

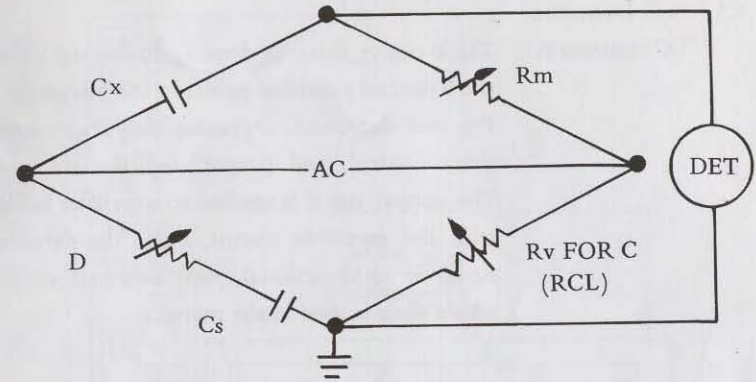

C. Inductance bridge

The Maxwell bridge is used for inductance measurements, where

$$L_x = R_m \times R_v \times C_s$$

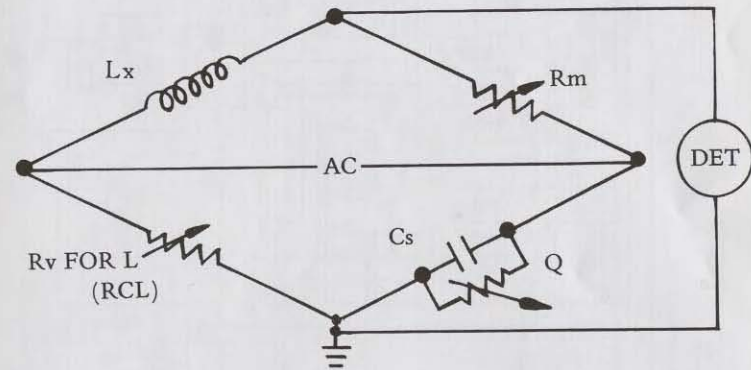

3.2 Bridge Sources

The internal 9V battery is used as the source for DC resistance measurements. When measuring C and L, the signal is generated with a two-transistor oscillator at 1kHz.

3.3 Null Detection

DC resistance: The 0-center meter is directly connected across the balanced potential points in the bridge. For null detection, a preamplifier stage, sensitivity control, and output amplifier are used. The output signal is applied to a rectifier bridge with the meter in circuit. Since the detected signal is unidirectional, only one-half of the whole scale is used in the meter.

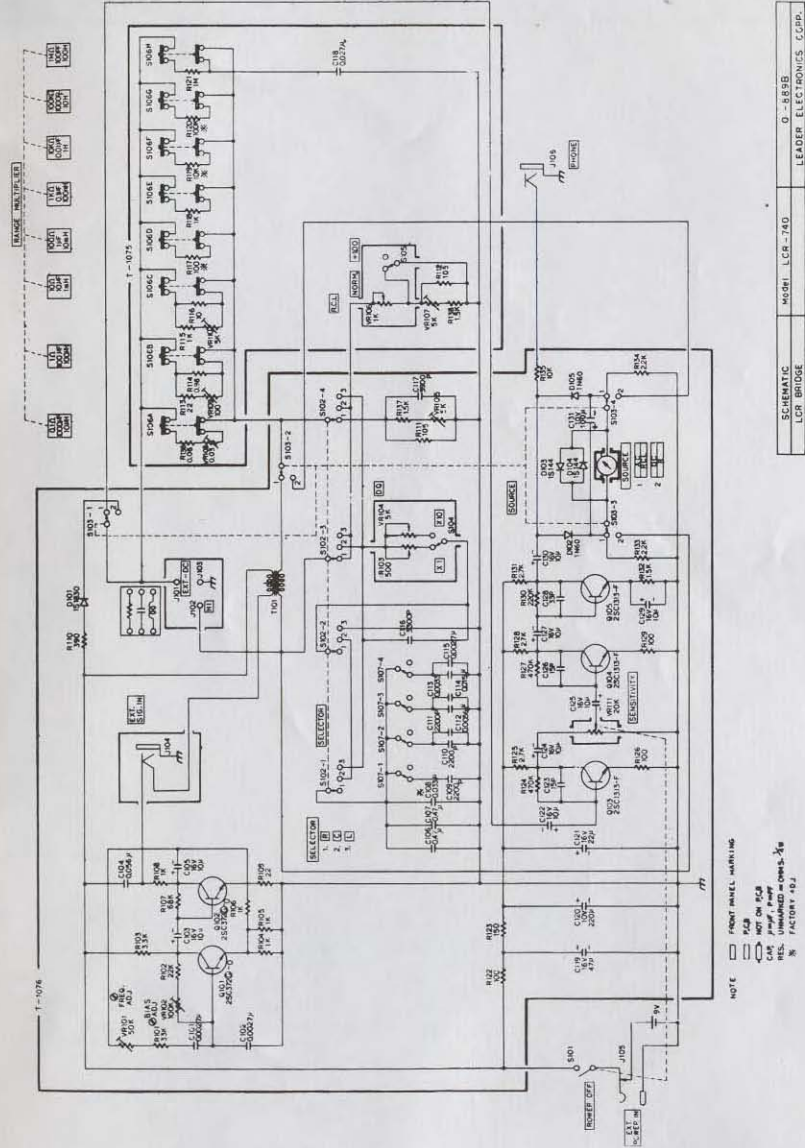

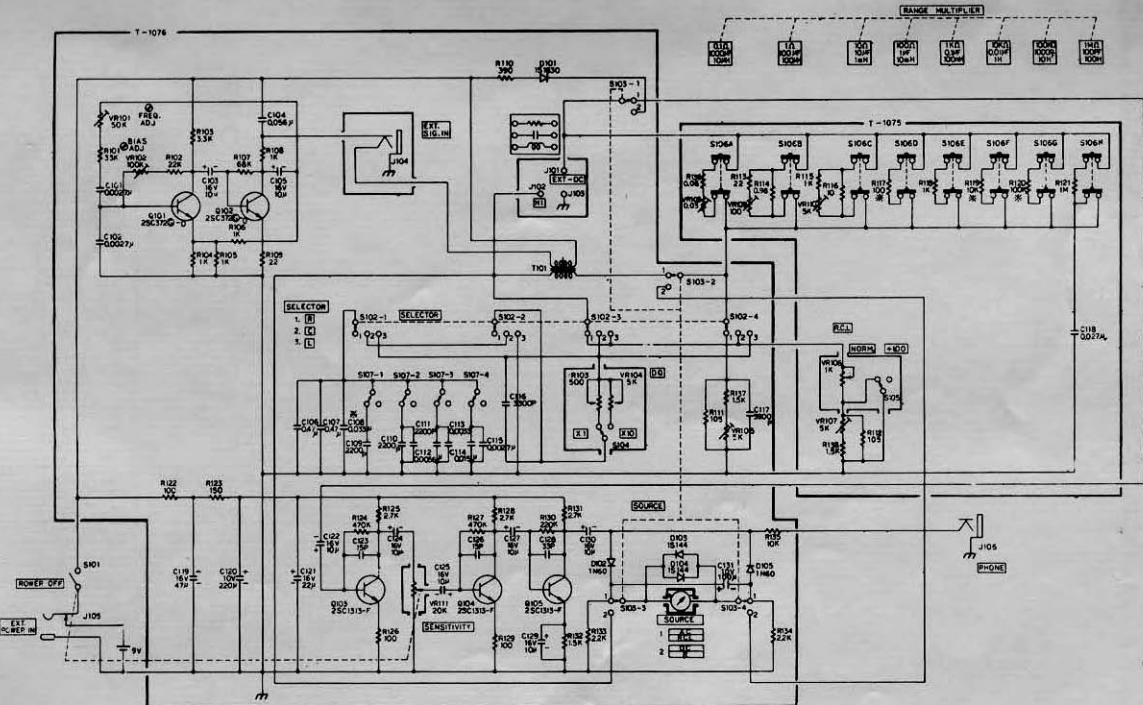

NOTE

- FRONT PANEL MARKING
- ▭ PCB
- ◊ NOT ON PCB
- CAS. μ mf, P=mpf
- RES. UNSHARDED = OHMS, $\frac{1}{2}$ "
- Ⓜ FACTORY ADJ.

SCHEMATIC	Model LCR-740	0-889B
LCR BRIDGE		LEADER ELECTRONICS CGPP.

K4XL's **BAMA**

This manual is provided **FREE OF CHARGE** from the "BoatAnchor Manual Archive" as a service to the Boatanchor community.

It was uploaded by someone who wanted to help you repair and maintain your equipment.

If you paid anyone other than BAMA for this manual, you paid someone who is making a profit from the free labor of others without asking their permission.

You may pass on copies of this manual to anyone who needs it. But do it without charge.

Thousands of files are available without charge from BAMA. Visit us at <http://bama.sbc.edu>